

Serie J9



Valvole a farfalla wafer
Wafer butterfly valve

DOWNLOAD
DATASHEET



b-Smart, Be-Brandoni



brandoni
VALVES

www.brandonivalves.com

Le valvole serie J9 sono valvole di intercettazione a farfalla con disco centrato con corpo tipo wafer in ghisa sferoidale o acciaio inox, realizzate in accordo alle normative di prodotto rilevanti ed al sistema di gestione della qualità EN ISO 9001.

Sono adatte per riscaldamento e condizionamento (HVAC), trattamento e distribuzione dell'acqua, applicazioni industriali, agricole, per aria compressa, gas, oli e idrocarburi. (Fatta salva la scelta corretta dell'articolo in base all'applicazione)

Sono idonee: per impieghi in linea e a fine linea, e per servizio che richiede frequenti azionamenti; il supporto integrato in accordo a ISO 5211 permette il facile montaggio di una ampia gamma di servocomandi.

Sono idonee per parzializzazione e regolazione della portata.

Non sono idonee: per vapore.

Accessori

- Prolunga per presa stradale
- Indicatore visivo e lucchettaggio per riduttore manuale
- Box micro per riduttore manuale
- Kit interruttori di finecorsa per segnalazione Aperto/Chiuso

Comandi

- Attuatori pneumatici a doppio e semplice effetto
- A richiesta: box finecorsa, posizionatore
- Attuatori elettrici
- Riduttori manuali
- Comando a catena

Certificazioni / Certifications



Conformi alla direttiva 2014/68/UE (ex 97/23/CE PED)
Conformi al D.M. 174 (direttiva 98/83/CE) e all'UNI EN 1074-1:2001 - UNI EN 1074-2:2004

Norme costruttive e di collaudo (equivalenti):

Scartamento: EN558/1-20 (ISO 5752-20, DIN 3202K1)
Flange: EN1092 ISO 7005, ANSI B16.5 #150
Design: EN593, EN12516, ISO 5211, EN12570
Marcatura: EN19
Collaudo: testate al 100% EN 12266 cat. A (ISO 5208 cat. A)

The shut-off wafer butterfly valves in Series J9 are equipped with a centred disc and wafer type body, and are made of ductile iron or stainless steel, manufactured in accordance with severe product norms and in conformity to EN ISO 9001. These valves are suitable for heating and conditioning (HVAC), water treatment and water distribution, industrial applications, agricultural purposes for compressed air, gas, oils and hydrocarbons. (Please ensure the choice of the corresponding item)

YES: for in line and end of line installation with frequent actuation; the integrated support, in accordance with ISO 5211, allows easy mounting of a wide range of actuators and drives.

They are suitable for choking and regulating the flow.

NO: for steam.

Accessories

- Extension for main water system connection
- Position indicator and padlocking for gear box
- Micro-switch for gear box
- Kit: micro-switches for ON/OFF position indicator

Actuators

- Double acting and single acting pneumatic actuators
- On request: micro-switches, position indicators
- Electric actuators
- Gear box
- Chain driven control

In conformity with directive 2014/68/UE (ex 97/23/CE PED)
In conformity with D.M. 174 (directive 98/83/CE) and with UNI EN 1074-1:2001 - UNI EN 1074-2:2004

Design and testing standards (correspondences):

Face-to-face: EN558/1-20 (ISO 5752-20, DIN 3202K1)
Flanges: EN1092 ISO 7005, ANSI B16.5 #150
Design: EN593, EN12516, ISO 5211, EN12570
Marking: EN19
Testing: 100% testing in accordance with EN 12266 cat. A (ISO 5208 cat. A)

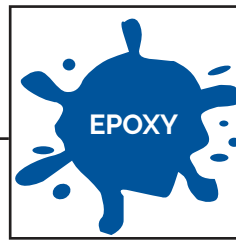

Verniciatura interna ed esterna con smalto epossidico, resistente alle alte temperature. Vernice a base acqua, a basso impatto ecologico. Spessore 150 μ .

Inside and outside epoxy coating, high temperature resistant. Environmentally friendly, water-based paint. 150 μ thickness.



Leva regolabile in posizioni intermedie.

Lever suitable for intermediate regulation.

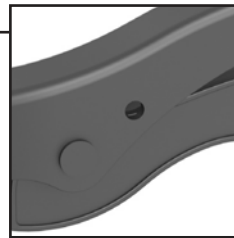

Leva lucchettabile.

Lockable operation lever.

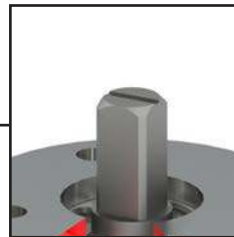

Una tacca fresata alla sommità dello stelo indica la posizione della lente ed evita errori di posizionamento in caso di smontaggio e rimontaggio del comando.

A notch machined at the top of the stem indicates the position of the disc and allows adjusting the lever/actuator to the correct position, when the command/lever is removed.

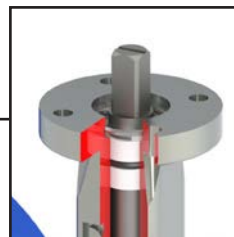

Flangia in accordo a ISO 5211 integrata.

Integrated ISO 5211 flange.

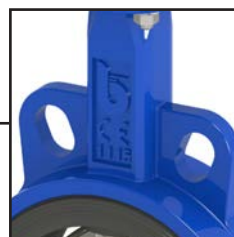

Asole di centraggio. Permettono il montaggio tra flange PN 6, PN10, PN16 e ANSI 150 per DN25-400. Per DN450-600 asole di centraggio per flange PN10 o PN16.

Alignment holes. Suitable for mounting between PN6, PN10, PN16 and ANSI 150 for DN 25-400

For DN 450-600 stainless steel for PN 10 and PN 16 flanges.

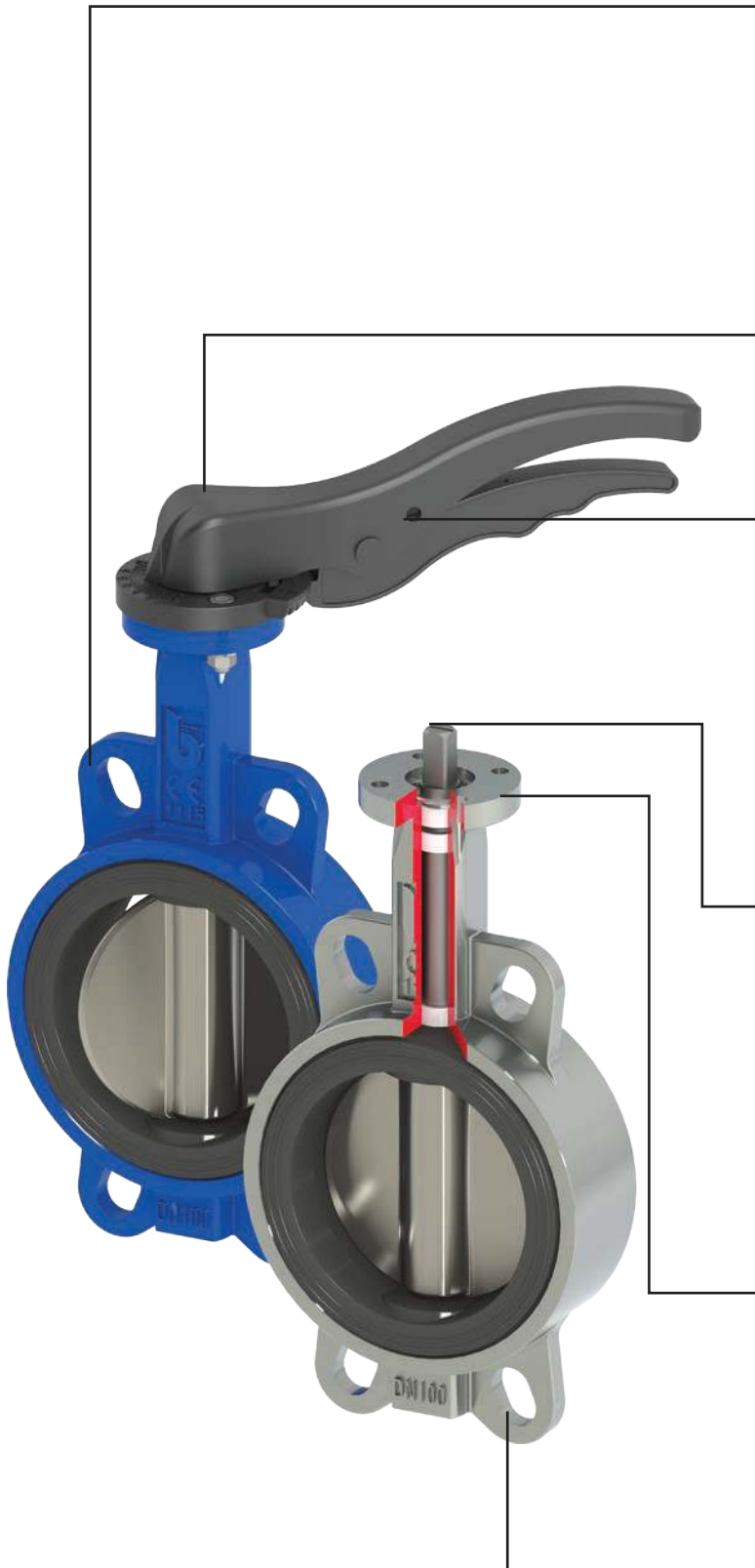

EPDM



J9.100

Corpo: ghisa sferoidale
Lente: ghisa sferoidale nichelato
Manicotto: EPDM
Temp: da -10 a +120°C

*Body: ductile iron
Disc: nickel plated ductile iron
Liner: EPDM
Temp: -10 a +120°C*



J9.120

Corpo: ghisa sferoidale
Lente: AISI 316
Manicotto: EPDM
Temp: da -10 a +120°C

*Body: ductile iron
Disc: AISI 316
Liner: EPDM
Temp: -10 a +120°C*



J9.128

Corpo: ghisa sferoidale
Lente: AISI 316
Manicotto: EPDM
Temp: da -10 a +120°C
Approvato Wras fino a 80°C

*Body: ductile iron
Disc: AISI 316
Liner: EPDM
Temp: -10 a +120°C
Wras approv. up to 80°C*



J9.170

Corpo: ghisa sferoidale
Lente: Bronzo-alluminio
Manicotto: EPDM
Temp: da -10 a +120°C

*Body: ductile iron
Disc: Aluminium-bronze
Liner: EPDM
Temp: -10 a +120°C*

NBR



J9.101

Corpo: ghisa sferoidale
Lente: ghisa sferoidale nichelato
Manicotto: NBR
Temp: da -10 a +80°C

*Body: ductile iron
Disc: nickel plated ductile iron
Liner: NBR
Temp: -10 a +80°C*



J9.101 gas

Corpo: ghisa sferoidale
Lente: ghisa sferoidale nichelato
Manicotto: NBR
Temp: da -10 a +70°C

*Body: ductile iron
Disc: nickel plated ductile iron
Liner: NBR
Temp: -10 a +70°C*



J9.121

Corpo: ghisa sferoidale
Lente: AISI 316
Manicotto: NBR
Temp: da -10 a +80°C

*Body: ductile iron
Disc: AISI 316
Liner: NBR
Temp: -10 a +80°C*



J9.121 gas

Corpo: ghisa sferoidale
Lente: AISI 316
Manicotto: NBR
Temp: da -10 a +70°C

*Body: ductile iron
Disc: AISI 316
Liner: NBR
Temp: -10 a +70°C*

NBR



J9.171

Corpo: ghisa sferoidale
Lente: Bronzo-alluminio
Manicotto: NBR
Temp: da -10 a +80°C

*Body: ductile iron
Disc: Aluminium-bronze
Liner: NBR
Temp: -10 a +80°C*



J9.102

Corpo: ghisa sferoidale
Lente: ghisa sferoidale nichelato
Manicotto: FKM
Temp: da -10 a +150°C

*Body: ductile iron
Disc: nickel plated ductile iron
Liner: FKM
Temp: -10 a +150°C*



J9.122

Corpo: ghisa sferoidale
Lente: AISI 316
Manicotto: FKM
Temp: da -10 a +150°C

*Body: ductile iron
Disc: AISI 316
Liner: FKM
Temp: -10 a +150°C*



J9.172

Corpo: ghisa sferoidale
Lente: Bronzo-alluminio
Manicotto: FKM
Temp: da -10 a +150°C

*Body: ductile iron
Disc: Aluminium-bronze
Liner: FKM
Temp: -10 a +150°C*

PTFE



J9.103

Corpo: ghisa sferoidale
Lente: ghisa sferoidale nichelato
Manicotto: PTFE
Temp: da -10 a +120°C

Body: ductile iron
Disc: nickel plated ductile iron
Liner: PTFE
Temp: -10 a +120°C



J9.123

Corpo: ghisa sferoidale
Lente: AISI 316
Manicotto: PTFE
Temp: da -10 a +120°C

Body: ductile iron
Disc: AISI 316
Liner: PTFE
Temp: -10 a +120°C



J9.173

Corpo: ghisa sferoidale
Lente: Bronzo-alluminio
Manicotto: PTFE
Temp: da -10 a +120°C

Body: ductile iron
Disc: Aluminium-bronze
Liner: PTFE
Temp: -10 a +120°C

Lente AISI 316 / Disc AISI 316



J9.620 EPDM

Corpo: AISI 316
Lente: AISI 316
Manicotto: EPDM
Temp: da -10 a +120°C

Body: AISI 316
Disc: AISI 316
Liner: EPDM
Temp: -10 a +120°C



J9.621 NBR

Corpo: AISI 316
Lente: AISI 316
Manicotto: NBR
Temp: da -10 a +80°C

Body: AISI 316
Disc: AISI 316
Liner: NBR
Temp: -10 a +80°C



J9.622 FKM

Corpo: AISI 316
Lente: AISI 316
Manicotto: FKM
Temp: da -10 a +150°C

Body: AISI 316
Disc: AISI 316
Liner: FKM
Temp: -10 a +150°C



J9.623 PTFE

Corpo: AISI 316
Lente: AISI 316
Manicotto: PTFE
Temp: da -10 a +120°C

Body: AISI 316
Disc: AISI 316
Liner: PTFE
Temp: -10 a +120°C

Lente AISI 316 / Disc AISI 316



J9.628 EPDM

Corpo: AISI 316
Lente: AISI 316
Manicotto: EPDM
Temp: da -10 a +120°C

Approvato Wras fino a 80°C

Body: AISI 316
Disc: AISI 316
Liner: EPDM
Temp: -10 a +120°C
Wras approv. up to 80°C



J9.670 EPDM

Corpo: AISI 316
Lente: Bronzo-alluminio
Manicotto: EPDM
Temp: da -10 a +120°C

Body: AISI 316
Disc: Aluminium-bronze
Liner: EPDM
Temp: -10 a +120°C



J9.673 PTFE

Corpo: AISI 316
Lente: Bronzo-alluminio
Manicotto: PTFE
Temp: da -10 a +120°C

Body: AISI 316
Disc: Aluminium-bronze
Liner: PTFE
Temp: -10 a +120°C

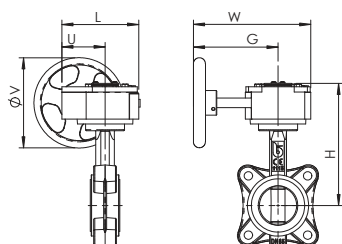

J9 + RM

Riduttore manuale

Gear box

DN	25	32	40	50	65	80	100	125	150	200	250	300	350	400
J9 + RM	RM.0250	RM.0250	RM.0250	RM.0250	RM.0250	RM.0250	RM.0250	RM.0250	RM.0250	RM.0750	RM.1200	RM.1200	RM.1200	RM.1200
L	130	130	130	130	130	130	130	130	130	180	205	205	205	278
U	77	77	77	77	77	77	77	77	77	104	124	124	124	118
H	166	172	178	188	198	212	232	242	262	308	346	372	415	457
W	225	225	225	225	225	225	225	225	225	338	345	345	345	291
G	170	170	170	170	170	170	170	170	170	260	260	260	260	167
V	150	150	150	150	150	150	150	150	150	300	300	300	300	380
Peso / Weight Kg	5,7	5,7	5,8	6,1	6,4	7,02	8,12	9,61	11,11	22,3	32,8	42	43	60

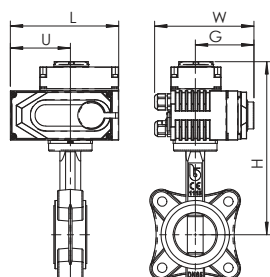

J9 + AOX

Attuatori elettrici

Electric actuators

DN	25	32	40	50	65	80	100	125	150	200	250	300	350	400
J9 + AOX	003	003	003	003	005	005	008	010	015	030	060	060	100	160
L	123	123	123	123	160	160	160	189	189	268	268	268	268	508
U	74	74	74	74	89	89	89	107	107	152	152	152	152	366
H	217	223	229	239	257	271	291	309	329	394	430	456	499	789
W	100	100	100	100	121	121	121	145	145	225	225	225	225	285
G	65	65	65	65	84	84	84	89	89	119	119	119	119	143
Peso / Weight Kg	3,8	3,8	3,9	4,2	6	6,8	7,9	10,9	12,4	28,4	37,3	43,7	45,2	115,7

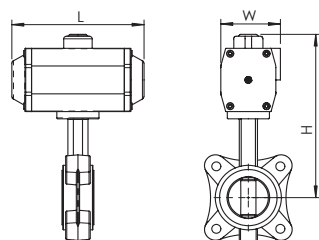

J9 + AP

Attuatori pneumatici

Pneumatic actuator

DN	25	32	40	50	65	80	100	125	150	200	250	300	350	400
J9 + AP DE	AP040	AP040	AP040	AP052	AP063	AP063	AP075	AP092	AP105	AP125	AP140	AP160	AP160	AP190
L	120	120	120	147	165	165	182	262	270	298	395	454	454	528
H	224	230	196	218	244	258	290	317	353	394	458	509	552	700
W	65	65	65	72	83	83	95	109	125	134	153	174	174	206
Peso / Weight Kg	2,7	2,7	2,8	3,3	4,4	5,2	6,9	10,9	13,8	23,7	37,5	-	-	-
J9 + AP SE - SPRING RETURN	AP052S	AP052S	AP063S	AP075S	AP083S	AP092S	AP105S	AP125S	AP140S	AP160S	AP190S	AP210S	AP240S	AP270S
L	147	147	165	182	208	262	270	298	395	454	528	536	608	721
H	236	242	224	246	315	337	373	344	452	447	606	657	744	798
W	72	72	83	95	103	109	125	134	153	174	206	226	260	294
Peso / Weight Kg	3,1	3,1	4	4,96	6	8,6	11,1	16,3	24,3	39,4	63,7	-	-	-



KPROg

Prolunga per presa stadale

Stem extension for water main system connection

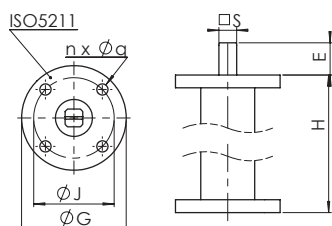

DN	40-100	125-150	200	250-300
H	250-500-800-1000			
ISO 5211	F05	F07	F10	F12
G	65	90	125	150
J	50	F07	F10	F12
n x Ø q	4 x 7	4 x 9	4 x 11	4 x 13
E	20	26	26	26
S	11	14	17	27

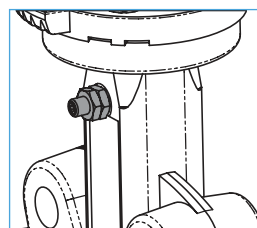

J9X

Conformi alla Direttiva Europea 2014/34/EU, ATEX II 2 GD IIB - dal DN 40 al DN 400 a richiesta

Complying with European Directive 2014/34/EU, ATEX II 2 GD IIB - DN40÷400 on request

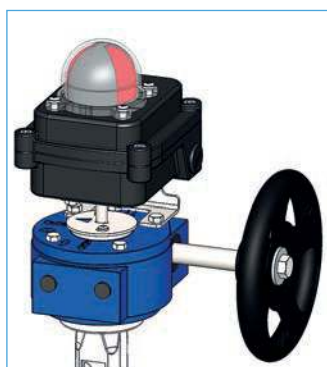

KBOXRM

Box micro per riduttore manuale

Limit switches box for gear box

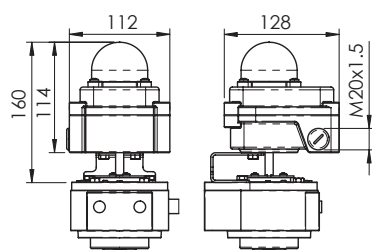

Versione standard con micro meccanici. A richiesta con micro di prossimità, anche in esecuzione ATEX

Mechanical switches per standard. Available on request: proximity switches, ATEX explosion proof proximity switches.

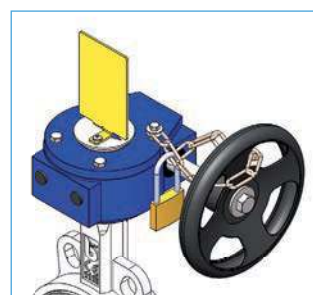

KPOSRM

Indicatore visivo e licchettaggio per riduttore manuale

Position indicator and padlocking for gear box

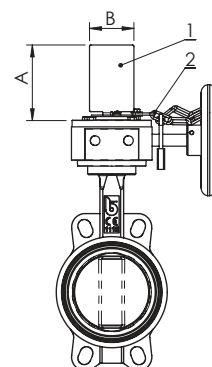

DN	25-150	200-400
A	100	120
B	60	80

- 1) Indicatore visivo di posizione
 - 2) Catena per licchettaggio
- 1) Position indicator
2) Chain for padlocking

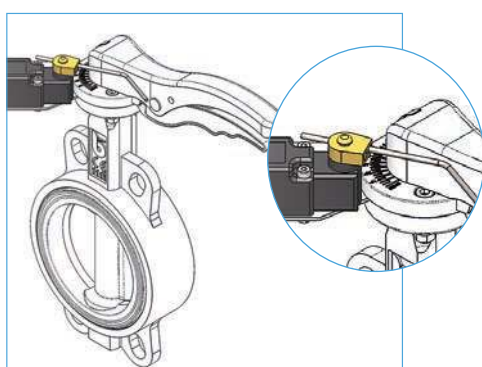

KFC109

Kit interruttori di finecorsa per segnalazione Aperto/Chiuso

Limit switches kit for ON-OFF indication

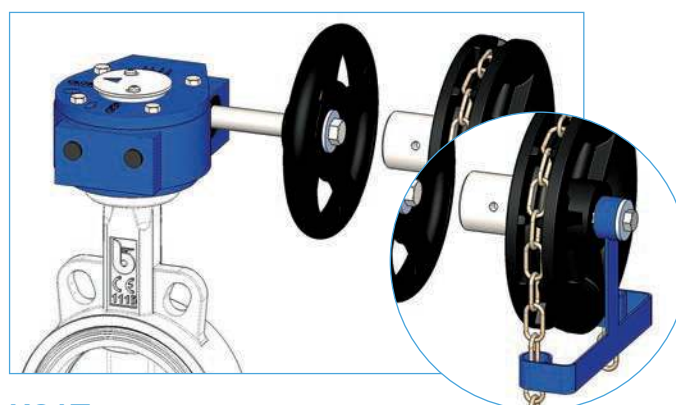

KCAT

Comando a catena

Chain driver kit

I componenti ed accessori realizzati in acciaio NON inox, anche se protetti da verniciatura, zincatura o altro trattamento, se utilizzati in ambienti all'aperto, in condizioni di forte umidità/condensa od in ambienti aggressivi, possono mostrare una durata di protezione all'ossidazione limitata nel tempo.
Components and accessories made in steel different from stainless steel, even if protected by painting or galvanizing, if used in outdoor environments, in conditions of high humidity / condensation or in aggressive environments, may exhibit a limited protection span against oxidation.

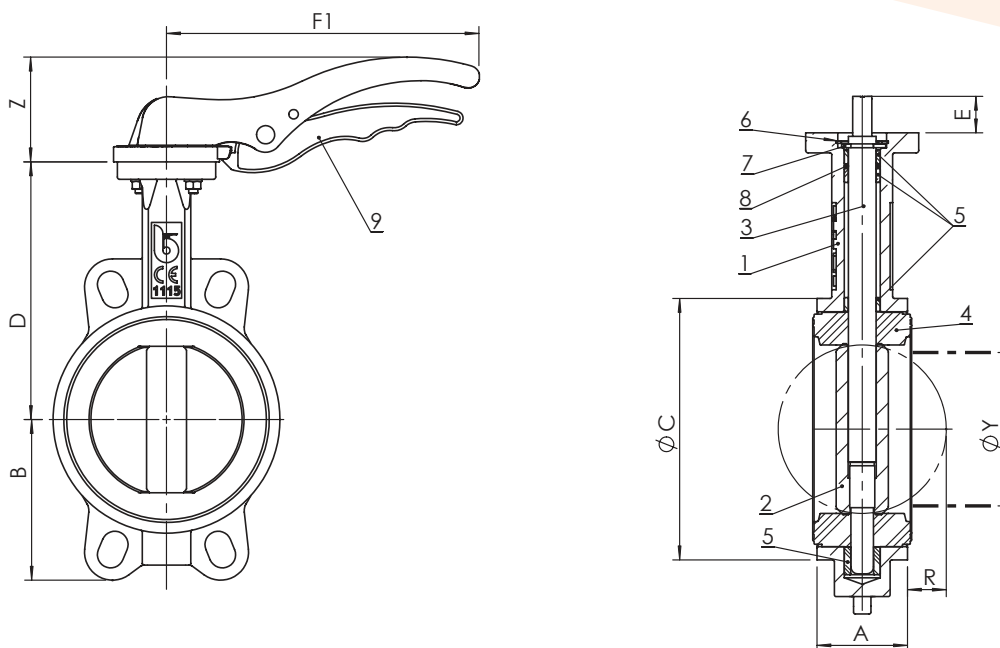

Dimensioni (mm) / Dimensions (mm)

DN	25	32	40	50	65	80	100	125	150	200	250	300	350	400	450	500	600
A	33	33	33	43	46	46	52	56	56	60	68	78	78	102	114	127	154
ØC	65	73	82	89	102	118	150	174	205	260	318	376	406	471	539	594	695
D	104	110	116	126	136	150	170	180	200	230	266	292	335	360	422	480	562
B	51	56	63	62	69	90	106	119	131	166	202	235	257	292	317	358	447
F1	192	192	170	170	170	206	206	285	285	400	530	-	-	-	-	-	-
Z	68	68	50	50	50	69	69	90	90	72	72	-	-	-	-	-	-
R	-	1	5	5	9	17	26	34	50	71	91	112	128	144	163	182	219
ØY min tubo/min pipe	-	12	27	31	45	65	90	110	146	194	241	291	324	379	428	475	573

NOTA: le valvole con EPDM, NBR e FKM ≥ DN 300 e quelle con PTFE ≥ DN 125 verranno fornite con RIDUTTORE MANUALE/

NOTE: valves with EPDM, NBR and FKM ≥ DN 300 and those with PTFE ≥ DN 125 will be supplied with MANUAL REDUCER

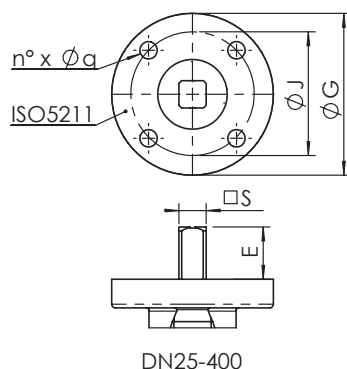

DN25-400

DN	25	32	40	50	65	80	100	125	150	200	250	300	350	400	450	500	600
ISO 5211	F05	F05	F05	F05	F05	F05	F05	F07	F07	F10	F12	F12	F12	F12	F14	F14	F16
G	65	65	65	65	65	65	65	90	90	125	150	150	150	150	175	175	210
J	50	50	50	50	50	50	50	70	70	102	125	125	125	125	140	140	165
n x q	4 x 7	4 x 7	4 x 7	4 x 7	4 x 7	4 x 7	4 x 7	4 x 9	4 x 9	4 x 11	4 x 13	4 x 13	4 x 13	4 x 13	4 x 18	4 x 18	4 x 22
S	7	7	9	9	9	11	11	14	14	17	27	27	27	27	32	32	36
E	32	32	21	21	21	21	21	27	27	27	27	27	27	27	52	65	70

1: vedi anche "Istruzioni e avvertenze" / 1: please see Instruction and Recommendations

Peso (kg) / Weight (kg)

DN		25	32	40	50	65	80	100	125	150	200	250	300	350	400	450	500	600
J9.1	con leva with lever	1,7	1,7	1,8	2,1	2,4	3,2	4,3	6,3	7,8	15,0	23,5	-	-	-	110	139	217
J9.6		-	-	-	2,1	2,4	3,1	4,1	6,1	7,5	14,1	22,8	-	-	-	-	-	-

Coppia di manovra (Nm) / Operating torque (Nm)

DN	25	32	40	50	65	80	100	125	150	200	250	300	350	400	450	500	600
DP bar																	
3	2,9	4,7	7,8	11,3	17	23	33	48	68	120	189	290	298	481	-	-	-
6	3,1	5,1	8,4	12	18	25	36	54	78	134	212	316	347	551	-	-	-
10	3,3	5,4	8,8	13	20	26	40	61	88	148	234	342	396	622	1'312	1'848	3'005
16	3,4	5,7	9,2	13	21	28	44	68	99	162	257	367	550	850	1'543	2'112	3'535

N.B. al fine di ottimizzare la scelta del servocomando si consiglia di moltiplicare il momento torcente per il coefficiente di sicurezza K=1,5

N.B.: In order to choose the right actuator, we recommend multiplying the operating torque figure by a safety coefficient, K=1.5

Diametro minimo del tubo Y / Minimum pipe diameter Y

Per garantire la completa apertura del disco assicurarsi che il diametro interno della tubazione ecceda i seguenti valori

To ensure complete disc opening, make sure that the inner diameter of the pipe exceeds the following values

DN	25	32	40	50	65	80	100	125	150	200	250	300	350	400	450	500	600
	-	12	27	31	45	65	90	110	146	194	241	291	324	379	428	475	573

Tabella flange / Flange chart Per montaggio tra flange/For mounting between flanges

	25	32	40	50	65	80(1)	100	125	150	200	250	300	350	400	450	500	600
PN6 EN1092	v (A)	v (A)	v (A)	v (A)	v (A)	v (D)	v (B)	v (A)	v (A)	v (A)	v (A)	v (A)	v (A)	v (A)	X	X	X
PN10 EN1092	v (A)	v (A)	v (A)	v (A)	v (A)	v (C)	v (A)	v (A)	v (A)	v (A)	v (A)	v (A)	v (A)	v (A)	v (A)	v (A)	v (A)
PN16 EN1092	v (A)	v (A)	v (A)	v (A)	v (A)	v (C)	v (A)	v (A)	v (A)	v (A)	v (A)	v (A)	v (A)	v (A)	v (A)	v (A)	v (A)
#150 ANSI B16.5	v (A)	v (A)	v (A)	v (A)	v (A)	v (D)	v (A)	v (A)	v (A)	v (A)	v (A)	v (A)	v (A)	v (A)	X	X	X

X: montaggio non possibile / mounting not allowed

V Montaggio possibile / mounting allowed

A, B, C, D: disposizione bulloni I / Bolt arrangement

(1): per DN80 PN10-16 a 4 fori vedi disposizione bulloni D / for DN80 PN10-16 with 4 holes see bolt arrangement D

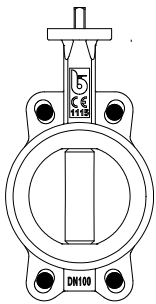

A

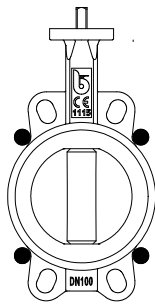

B

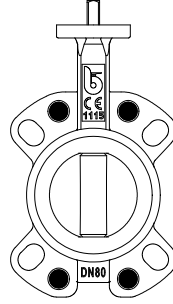

C

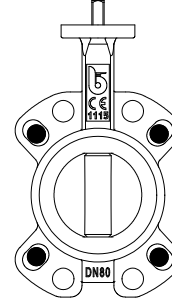

D

Calcolo lunghezza bulloni / Bolt length calculation

Montaggio con viti / Mounting with screws

Montaggio con tiranti / Mounting with tie-rods

$$L1 \geq A+2T+w+N$$

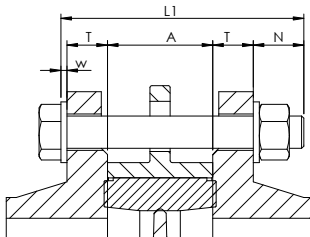

$$L2 \geq A+2T+2N$$

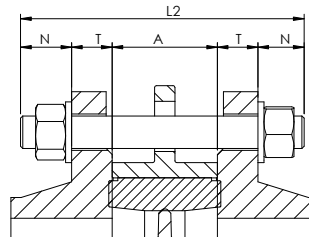

DN	25	32	40	50	65	80(1)	100	125	150	200	250	300	350	400	450	500	600
A	33	33	33	43	46	46	52	56	56	60	68	78	78	102	114	127	154
N*	18	24	24	24	24	24	24	26	26	26	32	32	32	32	32	36	40

T = spessore flangia (flangia cliente)

w = spessore rondella sotto la testa della vite

T = flange thickness (customer)

w = thickness of washer at the screw head

* Massimo tra EN1092 PN6/10/16 and ANSI 150 / Max among: EN1092 PN6/10/16 and ANSI 150.

** Non forniamo bulloneria / We do not supply the bolting.

Flange raccomandate / Recommended flange types

Norma / Norms	Tipo / Type	
EN 1092-1 PN6/10/16	Tipo / Type 11	A collarino / weld neck
	Tipo / Type 21	Integrale / integral
	Tipo / Type 02 + 35	Scorrevoli con collare a saldare / loose plate with weld ring neck
	Tipo / Type 02 + 36	Scorrevoli con collare pressato / loose plate with pressed collar
	Tipo / Type 04 + 34	Scorrevoli con collare a saldare / loose plate with weld neck collar
ANSI B16.1#150° ANSI B16.5#150°		Faccia piana / flat face
		Con risalto / raised face
		Scorrevoli / lap joint

Materiali / Materials

	Componente Component	Materiale / Material	
		J9.1	J9.6
1	Corpo Body	Ghisa sferoidale - Ductile iron EN GJS 400 - 15	Acciaio inox - Stainless steel ASTM A351 gr. CF8-M
2	Disco Disco	Ghisa sferoidale Nichelato - Nickel plated Ductile iron EN GJS 400 - 15 / Acciaio inox - Stainless steel ASTM A351 gr. CF8-M / Bronzo-Alluminio - Aluminium-bronze C95800 ASTM B148	Acciaio inox - Stainless steel ASTM A351 gr. CF8-M / Bronzo-Alluminio - Aluminium-bronze C95800 ASTM B148
3	Asta DN25-400 Stem DN25-400	AISI 420	AISI 316
	Asta DN450-600 Stem DN450-600	AISI 416	AISI 316
4	Manicotto Liner	EPDM / NBR / FKM (Viton®) / PTFE	
5	Bussola Bushing	PTFE	
6	Rosetta Washer	Acciaio al carbonio zincato Galvanized carbon steel	Acciaio inox A4 Stainless steel A4
7	Anello ISO3075 Circlip ISO3075	Acciaio per molle Spring steel	Acciaio inox A4 Stainless steel A4
8	O-Ring O-ring	FKM (Viton®)	
9	Leva Lever	DN25-150 Alluminio-aluminium / DN200-250 Ghisa sferoidale - Ductile iron EN GJS 400-15	
10	Bulloneria Bolts	Acciaio inox AISI 201 Stainless steel AISI 201	Acciaio inox A4 Stainless steel A4

Pressione massima / Maximum pressure

Tipo fluido * / Fluids *	Montaggio / Mounting	
	TRA FLANGE / BETWEEN FLANGES	FINE LINEA / END OF LINE
Gas pericolosi Hazardous gases	16 bar DN25-200 10 bar DN250-350 NO DN400-600	10 bar DN25-100 NO DN125-600
Liquidi pericolosi Hazardous liquids	16 bar DN25-400 10 bar DN450-600	10 bar DN25-400 6 bar DN450-600
Gas non pericolosi Non hazardous liquids	16 bar DN25-300 10 bar DN350-500 6 bar DN600	10 bar DN25-300 6 bar DN350-500 4 bar DN600
Liquidi non pericolosi Non hazardous liquids	16 bar DN25-400 10 bar DN450-600	10 bar DN25-400 6 bar DN450-600
Acqua** Water**	16 bar	16 bar

* gas, liquidi pericolosi secondo 2014/68/EU e 1272/2008 (CLP)

** Per la raccolta, distribuzione e deflusso di acqua (PED 2014/68/EU 11.2b)

* hazardous gas, liquids acc. 2014/68/EU e 1272/2008 (CLP)

** For supply, distribution and discharge of water (PED 2014/68/EU 11.2b)

Temperatura / Temperature

Temperatura Temperature	min °C	max°C - Max°C	
		continuo / continuous	picco / peak
EPDM	-10	120	130
NBR	-10	80	90
FKM (Viton®)	-10	150	170
PTFE	-10	120	120

Attenzione: la pressione massima di utilizzo diminuisce con la temperatura, vedi diagramma "Pressione/Temperatura"

NB: the maximum working pressure decreases while the temperature increases; please refer to "pressure/temperature" chart

Diagramma Pressione/Temperatura / Pressure/temperature chart

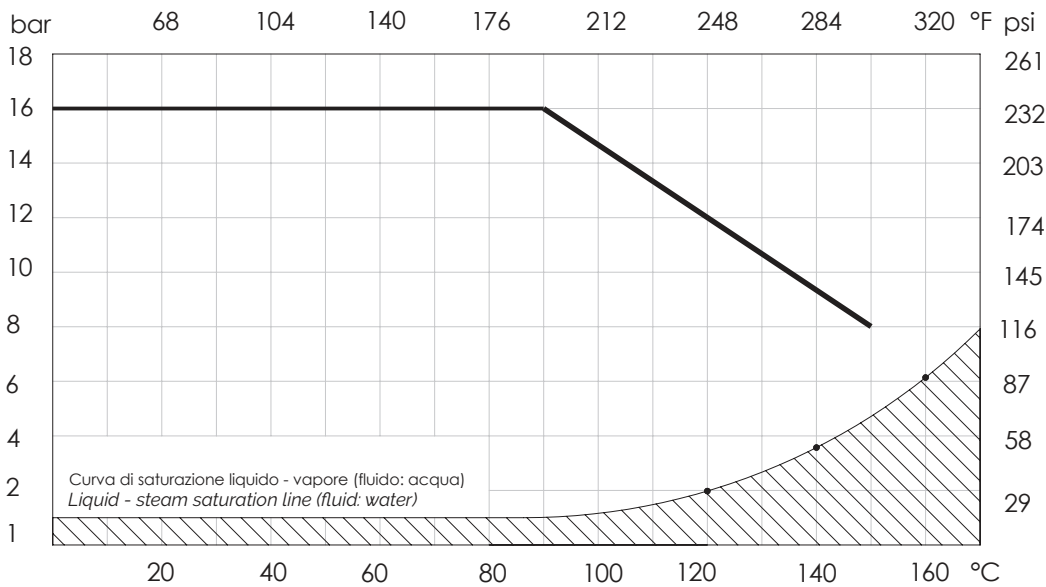

NON ADATTA PER VAPORE. NON utilizzare in condizioni di temperature e pressione al di sotto della curva di saturazione liquido-vapore (area tratteggiata)
RANGE NOT SUITABLE FOR STEAM. DO NOT use when temperature and pressure are below the liquid-steam saturation line (hatched area)

Perdite di carico Fluido: acqua (1m H₂O = 0,098bar) - Perdite di carico ad otturatore completamente aperto

Head loss Fluid: water (1m H₂O = 0,098bar) - Head loss with shutter fully opened

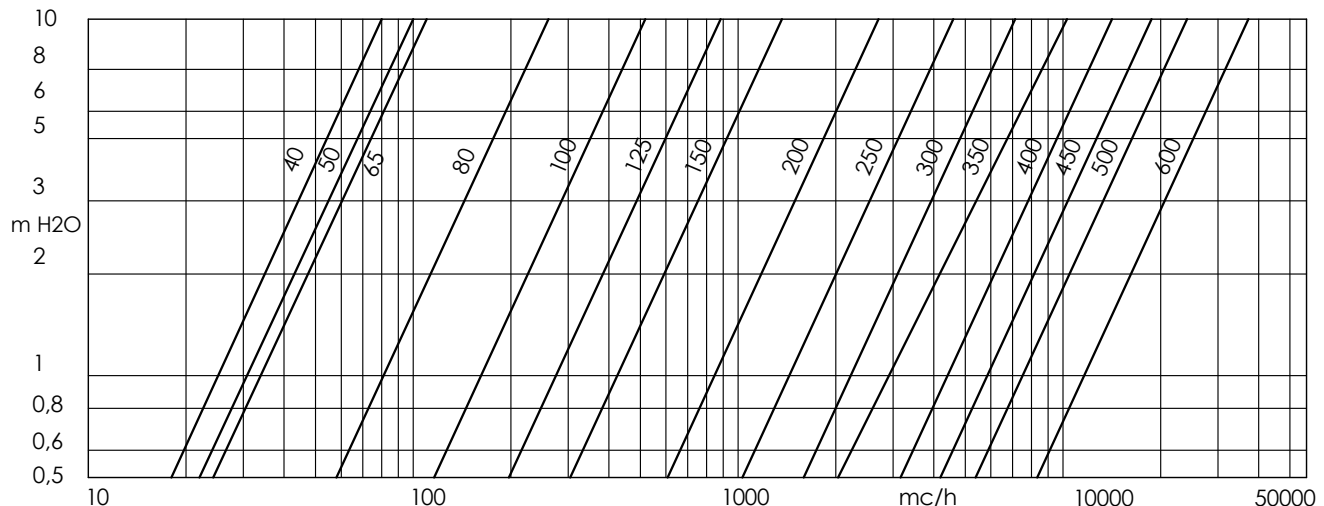

Curva delle portate/angolo di apertura Percentuale sulla portata a piena apertura a parità di perdita di carico.

Flow rate / opening position chart Flow percentage on the flow at full opening under the same loss of head.

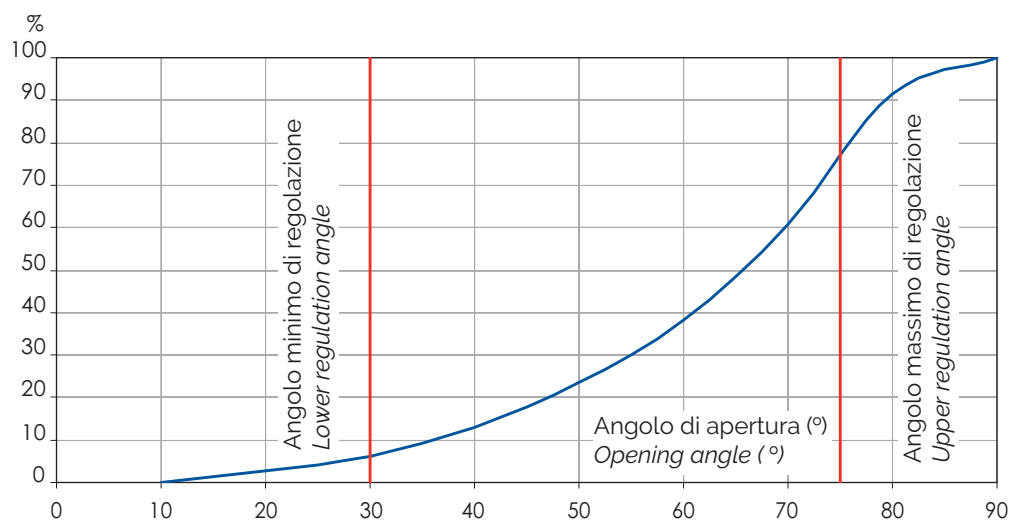

Tabella Kv - DN (mc/h per bar) / **Kv - DN chart** (mc/h per bar)

DN	mm	40	50	65	80	100	125	150	200	250	300	350	400	450	500	600
	ins	1" 1/2	2"	2" 1/2	3"	4"	5"	6"	8"	10"	12"	14"	16"	18"	20"	24"
10°	0,04	0,05	0,00	0,17	0,26	0,43	0,69	2,6	2,6	3,5	5,2	6,9	9,5	12	19	
20°	2,1	2,6	3,8	7,8	15	25	39	52	130	202	292	401	531	683	1055	
30°	4,8	6	14	16	31	53	82	142	276	427	617	849	1124	1445	2234	
40°	10	13	33	34	67	115	177	250	599	926	1376	1839	2437	3133	4840	
50°	19	23	53	60	120	205	316	450	1068	1650	2384	3279	4342	5609	8626	
60°	30	38	75	100	199	339	522	713	1768	2730	3945	5425	7185	9238	14272	
70°	48	60	98	158	314	535	827	1122	2798	4322	6243	8585	11371	14620	22587	
80°	73	91	108	237	471	803	1241	1723	4196	6483	9364	12878	17057	21930	33882	
90°	79	99	108	261	518	883	1364	2716	4611	7124	10291	14152	18743	24099	37232	

I dati e le caratteristiche di questo catalogo sono forniti a titolo indicativo. La Brandoni S.p.A. si riserva di modificare una o più caratteristiche delle valvole senza preavviso. Per maggiori informazioni www.brandonivalves.com.

Brandoni SpA reserves the right to make changes in design and/or construction of the products at any time without prior notice. For further information, please refer to www.brandonivalves.com